

# Performance of Electrical Water Decarbonizer For Engine Tune Up Purpose

*Azamataufiq Budiprasojo (a\*), Aditya Wahyu Pratama (b)*

- a) Engineering Departement, Politeknik Negeri Jember  
Jalan Mastrip poBox 164, Jember 68141, Indonesia  
\*azamataufiq@polije.ac.id  
azamataufiq@gmail.com
- b) Engineering Departement, Politeknik Negeri Jember

**Abstract.** Tuning up vehicles are routine, expensive, and time-consuming activities for vehicles owner. Prototype Portable Electrical Water Decarbonizer offers a new concept of cheap, easy, fast, effective and enviromental friendly tune up. This research is also solution for PT. YTL Paiton Probolinggo's problem. This research will started by the calculating and design the generator for split up water into two hydrogen atoms and one oxygen atom through electrolysis as the main component of prototype. From these calculations, a prototype will made as an Applied Technology Product. Changes in the performance characteristics of the generator will be analysed for one hour by its temperature, current, voltage, power, gas production flowrate, and the visualization of the combustion chamber as the effect of decarbonizer. Research result indicate : voltage recorded 12V min., 12.5V max. and 12.24V average; current recorded 19,34A min., 20,39A max. and 19.81A average; power recorded 239,25Watt min., 244,79watt max. and 242.72Watt average; electrolite water temperature 25°C min., 64 °C max., 50.51 °C average; gas production flow rate 0.925 L/min min., 1.479 L/min max., 1.27 L/min average. The before and after piston photograph indicated that this prototype decarbonize working properly.

**Keywords:** Water Decarbonizer, Tune Up, Enviromental Friendly, performance.

## Introduction

Machine damage can occur due to carbon in the combustion chamber due to incomplete combustion process. The process of cleaning carbon in the combustion chamber is usually done by, first manually dismantling the engine and then cleaning it (overhaul process), second by inserting the chemical into the engine without dismantling it. Both of these steps are equally inefficient because the cost of overhauling is expensive and the cost of buying cleaning chemicals is also relatively expensive and needs to remember as being very toxic and harmful to the environment.

The search for innovative ways to solve the above problems began to be consider by paying attention to the essence of carbon theoretically. Carbon in the combustion chamber is an atom that is reactive and easily forms bonds. If the carbon atom is met with an unstable atom of hydrogen oxygen, a covalent chemical bond is formed which is then disposed of with the exhaust gas. To produce hydrogen and oxygen that binds carbon in the combustion chamber, an electrolysis generator that is power by electricity is need.

In the research, a prototype tune up vehicle will made which is capable of removing residual carbon in the combustion chamber by using the ideas and principles described previously. Systematic calculations and designs need to done to make the optimal tool as a tool to tune up residual carbon cleaning vehicles in the combustion chamber. A microcontroller and heat fin will applied to ensure the generator works optimally.

Observation of temperature parameters, gas flow rate, electric current, voltage, and carbon content in the combustion chamber given this prototype will be the analysis data in this study.

## Methods

In this study will use an experimental approach methodology (Research Method), with a variant analysis model. It Start with the design process, including calculation of layout, materials, cells from the generator; Calculation of microcontroller type as current stabilizer; Heat Fin and Fan circuits to stabilize the temperature of the generator when producing hydrogen and oxygen. Observation of temperature parameters, gas flow rate, electric current, voltage, and carbon content in the combustion chamber given this prototype will be the analysis data in this study.

There are three main stages of this research:

1. Preparation: Includes literature study activities and formulation of formulas for designing generators to be able to produce hydrogen and oxygen gas with large and good discharge and quality. including calculation of layout, materials, cells from the generator; Calculation of microcontroller type as a current and voltage stabilizer; Heat Fin and Fan circuits to stabilize the temperature of the generator when producing hydrogen and oxygen.
2. Fabrication and performance testing: Includes generator fabrication activities in accordance with the formula that has been calculated, setting the equipment on the test vehicle, running prototypes, and observing temperature parameters, gas flow rate, electric current, voltage, and visualization of carbon content in the combustion chamber.
3. Finishing: Includes the activity of analyzing research data, drawing conclusions and making reports and publications.

Generator design, will be an Independent Variable; 12V power voltage, 1500 ml electrolysis water volume will be a Controlled Variable; Power, Current, Voltage, Gas Flowrate, temperature, and the visualization of the combustion chamber will be a Dependent Variable.

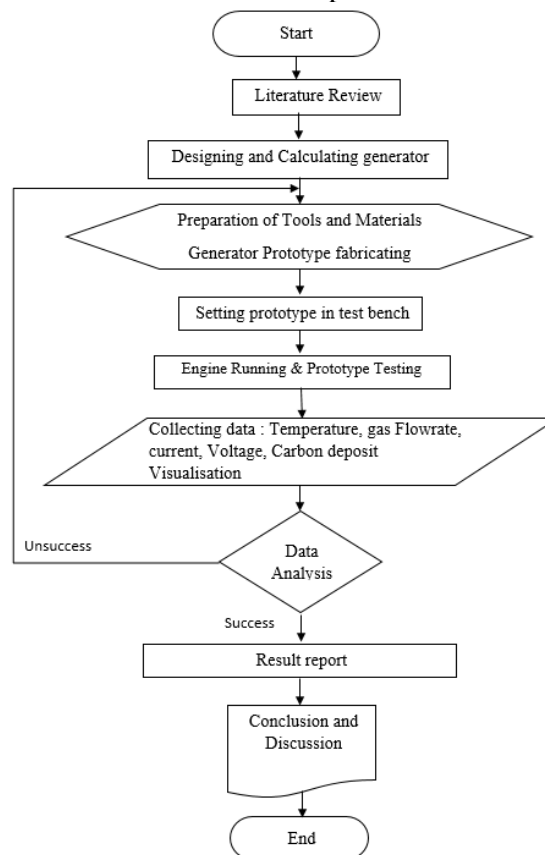

*Research Installation Models Used*

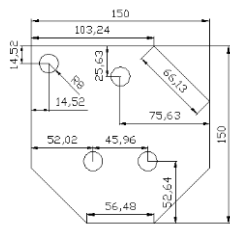

*Electrode Plat and Fin Heat Exchanger*

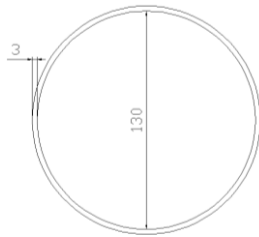

*Electrode Separator Gasket*

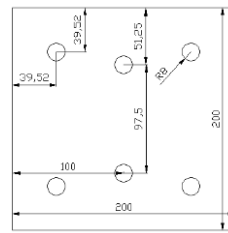

*Isolator*

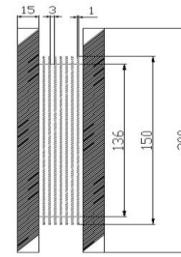

*Generator assembly*

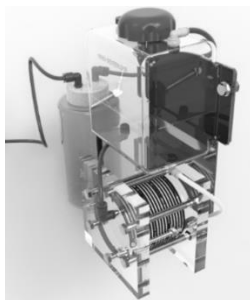

*3D Rendering Generator Assembly Model*

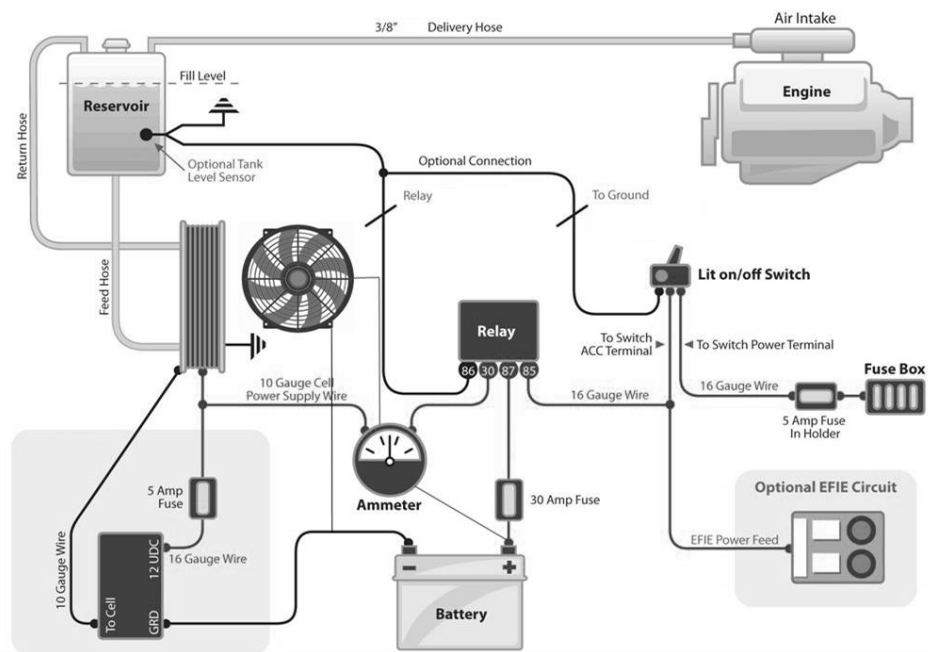

Picture 1. Components, Layout and Research Design Instalation Model

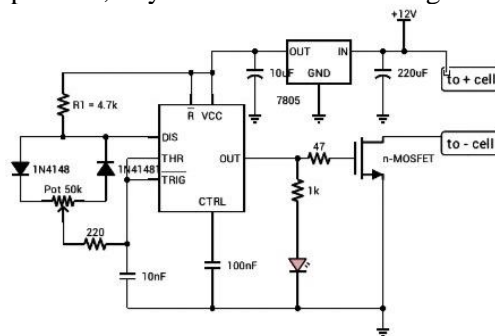

Picture 2. Pulse Width Modulator Electronic Circuit Layout

## Results

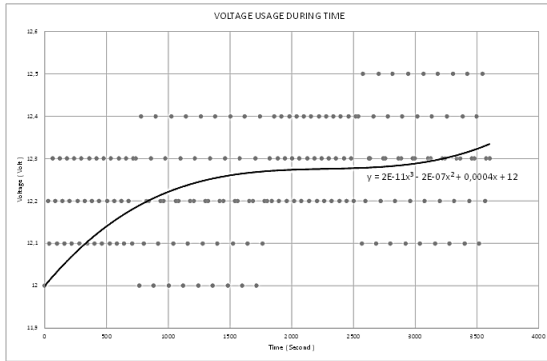

Voltage Usage

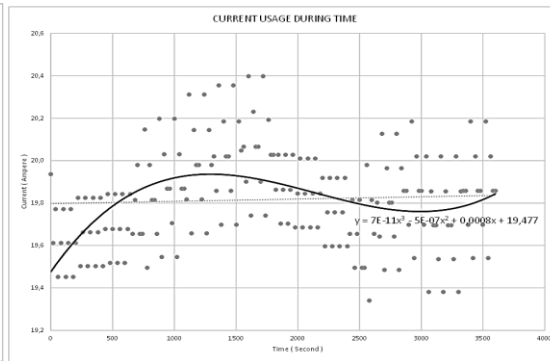

Current Usage

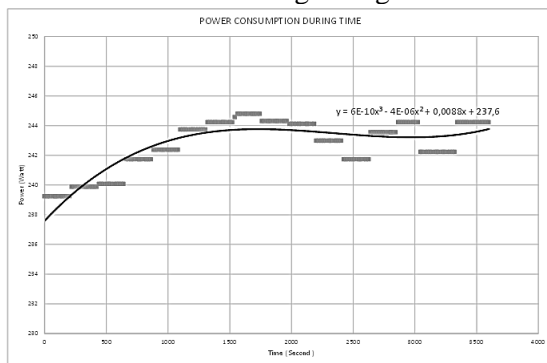



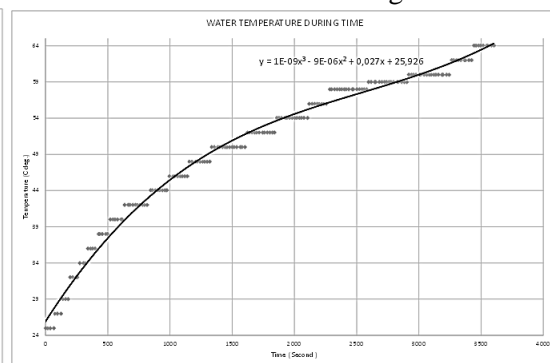

Power Usage

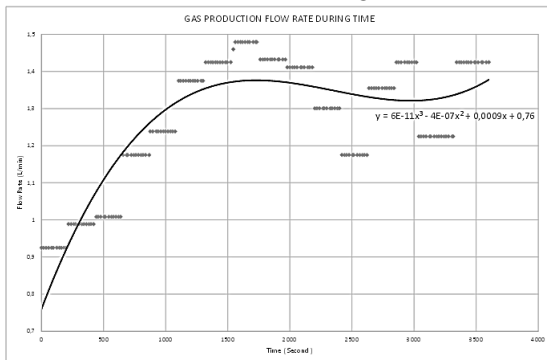

Water Temperature

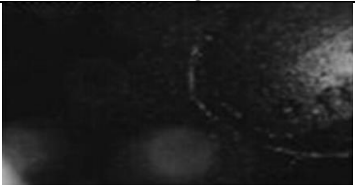
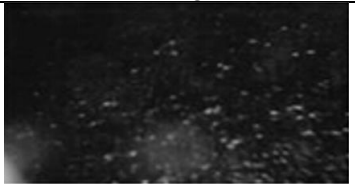
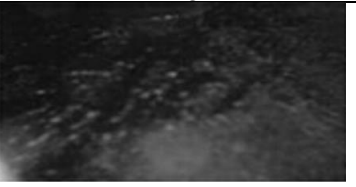

Gas Production Flowrate

	Single Cylinder 4 Stroke 160 CC Engine	Single Cylinder 2 Stroke 110 CC Engine	Single Cylinder 4 Stroke 110 CC Engine
Before			
After 1 Hours Decar - bonizer			

Picture 3. Piston Photograph

## Discussions

Research result indicate : voltage recorded 12V min., 12.5V max. and 12.24V average; current recorded 19,34A min., 20,39A max. and 19.81A average; power recorded 239,25Watt min., 244,79watt max. and 242.72Watt average; electrolite water temperature 25°C min., 64 °C max., 50.51 °C average; gas production flow rate 0.925 L/min min., 1.479 L/min max.,1.27 L/min average.

As seen in Picture 2, at the beginning of the test there is an increase in power, voltage and current as the test time increases, but at different times the power power, voltage and current consumption decreases. Power, voltage and current consumption obliteration is due to the increasing number of time by the affect of the viscosity changing. The viscosity of the liquid will be increasing during time.

The lower the electrical conductivity of the electrolyte solution, the greater the resistance of the electrolysis circuit, if the smaller the resistance value, the greater the power flowing. Based on Ohm's law with the same voltage, the electric current that can flow will also be smaller. This happens because the electrolyte liquid tends to be thick and the time when the solution will experience saturation which results in anions and cations in the electrolyte liquid when the electrolysis process becomes slow and can also affect the rate of production of the dihydrogen monoxide gas.

It is evident that the test results show that the higher the power, the higher the rate of production of dihydrogen Monoxide gas produced and vice versa, if the power decreases, the rate of production of dihydrogen monoxide gas will also decrease resulting from the electrolysis process.

From the graph of the relationship between the flowrate of dihydrogen monoxide gas production to the time of the experiment it can be seen that the rate of dihydrogen monoxide gas production continues to rise from the starting point of the test to the maximum time of testing.

The increase in the rate of dihydrogen monoxide gas production occurs in every percentage of catalyst, but the amount of dihydrogen monoxide gas production from the beginning of the testing time to the end of the test. The power also increases with increasing testing time because this is in accordance with the law of conservation of energy which states that the incoming energy is the same as the energy coming out. When gas production is large, a large amount of power is needed.

The difference in the flowrate of dihydrogen monoxide gas production is due to electrolyte liquid which tends to be concentrated and cause electrolyte to become saturated. Electrolyte fluid saturation affects the movement of anions and cations to slow their movement and cause electrodes - electrodes on the generator to rise in temperature / heat. This causes movement of anions and cations in the electrolyte solution also more difficult to move when delivering the lithic current, because the distance between the particles is too close so that the conductivity is low and the electrolysis reaction will not be optimal and the increase in the rate of dihydrogen monoxide gas production tends to decrease.

After 60 minutes appying prototype in motorcycle engine its show in picture 3 that this dihydrogen Monoxide gas can successfully clean up the carbon (decarbonizer process). The Dihydrogen Monoxide gas will bind carbon which results in the release of carbon from the combustion chamber. As a future research its need to be prove from exhaust gass analysis testing bench to get know how big the percentage of carbon looses during decarbonizer process

## Conclusion

Research result indicate : voltage recorded 12V min., 12.5V max. and 12.24V average; current recorded 19,34A min., 20,39A max. and 19.81A average; power recorded 239,25Watt min., 244,79watt max. and 242.72Watt average; electrolite water temperature 25°C min., 64 °C max., 50.51 °C average; gas production flow rate 0.925 L/min min., 1.479 L/min max.,1.27 L/min average. The before and after piston photograph indicated that this prototype decarbonize working properly.

## References

Abdel Ghany, N. A., Kumagai, N., Meguro, S., Asami, K., Hasimoto, K. 2002. "Oxygen Evolution Anodes Composed of Anodically Deposited Mn-Mo-Fe Oxides for Seawater Electrolysis". *Electrochimica Acta* 48.

Abdel-Aal, H.K., K.M. Zohdy dan M. Abdel Kareem, 2010. "Hydrogen Production Using Sea Water Electrolysis" *Fuel Cells Journal*, volume 3.

Abdel-Aal, H.K., Sultan, S.M., dan Hussein, I.A., 2013. "Parametric Study for Saline Water Elektrolysis: Part II- Chlorine Evolution, selectivity and Determination". *International Journal Hydrogen Energy* 18 (7).

Cole Parmer Instrument Co., 2005., "16 Series Mass and Volumetric Flow Meters". Vernon Hills: DOC-CPMAN16.

Hendri Chem., 2010., "Kimia Fisika\_Daya Hantar Listrik"., Artikel Kimia Daya Hantar Listrik.

Johanna Ivy., 2004., "Summary of Electrolytic Hydrogen Production"., Colorado: National Renewable Energy Laboratory.

O'Connor, Ken., Maret 2006., "Guide to Safety of Hydrogen and Hydrogen Systems"., BMS Document GLM-QSA-1700.1.